

Ara bağlantı eklemi / Interconnection joint

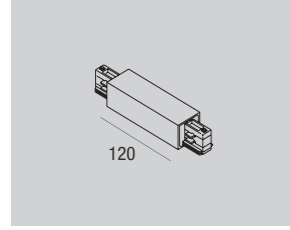

Model No
Model No

LDN-011001

Haraketli uç / Live-end

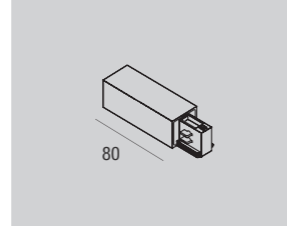

Model No
Model No

LDN-011007

X - Eklem / X - Joint

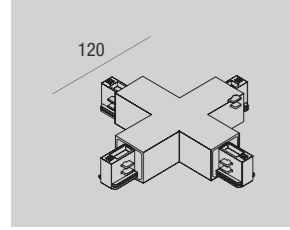

Model No
Model No

LDN-011002

L - Eklem / L - Joint

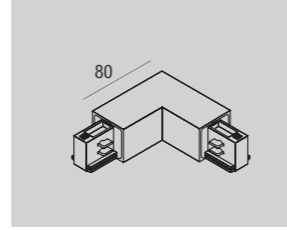

Model No
Model No

LDN-011008

Esnek eklem / Flexible joint

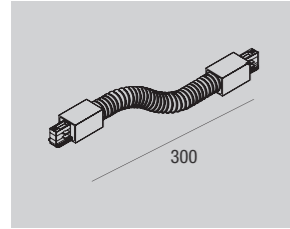

Model No
Model No

LDN-011003

T - Eklem / T - Joint

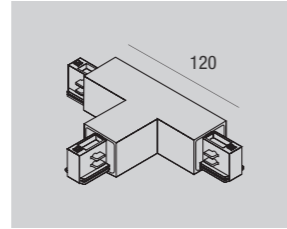

Model No
Model No

LDN-011009

Takviye braketi / Stiffening bracket

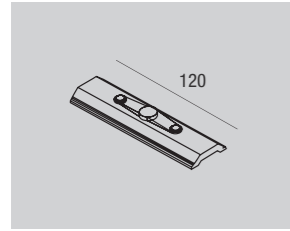

Model No
Model No

LDN-011004

Parça kapağı / Track cover

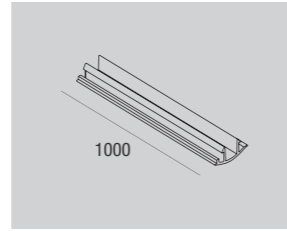

Model No
Model No

LDN-011010

Ara birleştirme eklemi / Intermediate joining joint

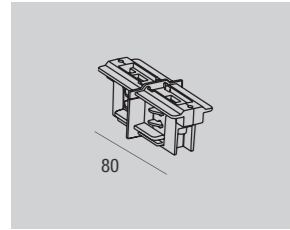

Model No
Model No

LDN-011005

Sabitleme Braketi / Fastening Bracket

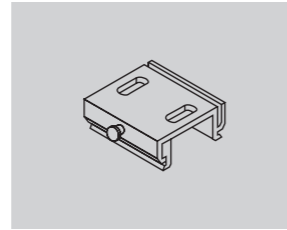

Model No
Model No

LDN-011011

Merkezi konnektör ve düz bağlantı / Central connector and straight joint

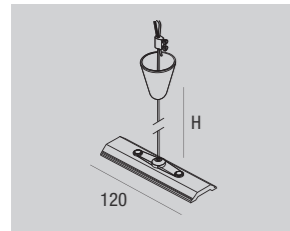

Model No
Model No

LDN-011006

Kilitleme aygıtı / Locking device

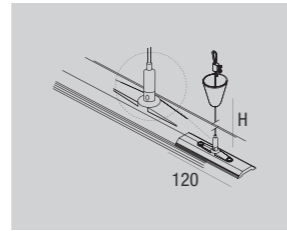

Model No
Model No

LDN-011012

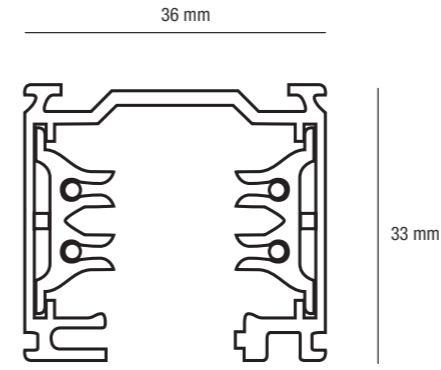

Model No Model No	Boy Length
LDN-100	1m
LDN-200	2m
LDN-300	3m



Özellikler / Specification

- Alüminyum profil gövde
- IP20 koruma sınıfı
- Taşıdığı yük : 100N (10 Kg)
- Bükme momenti : 2.5 Nm
- Koruma sınıfı : I
- Sıva üstü ve sarkıt montaj seçenekleri mevcuttur.
- Aluminium extruded body
- IP20 protection class
- Pull strength : 100N (10 Kg)
- Torque max : 2.5 Nm
- Protection class : I
- Both surface monting and suspension alternatives available.

